

No	l_1	l_2	h_1	h_2	P_1	P_2	P_3	q	M
1	2	3	4	2	12	6	0	6	0
2	3	3	4	3	0	10	8	8	24
3	4	3	5	3	14	6	0	4	0
4	2	4	4	2	20	0	8	6	0
5	3	3	5	4	0	12	6	1	16
6	4	3	5	4	12	0	8	8	0

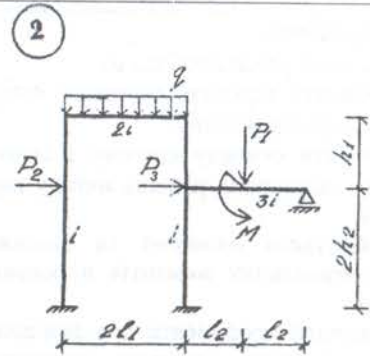

No	l_1	l_2	h_1	h_2	P_1	P_2	P_3	q	M
1	2	3	4	2	12	6	0	6	0
2	3	3	4	3	0	10	8	8	24
3	4	3	5	3	14	6	0	4	0
4	2	4	4	2	20	0	8	6	0
5	3	3	5	4	0	12	6	1	16
6	4	3	5	4	12	0	8	8	0

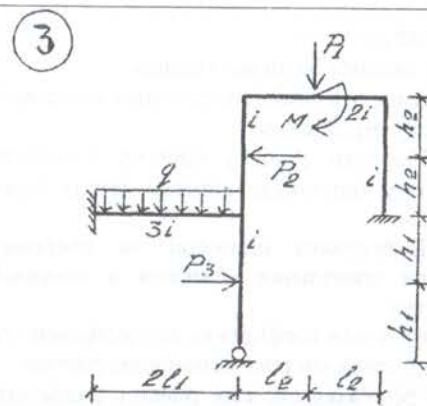

No	l_1	l_2	h_1	h_2	P_1	P_2	P_3	q	M
1	2	3	4	2	12	6	0	6	0
2	3	3	4	3	0	10	8	8	24
3	4	3	5	3	14	6	0	4	0
4	2	4	4	2	20	0	8	6	0
5	3	3	5	4	0	12	6	1	16
6	4	3	5	4	12	0	8	8	0

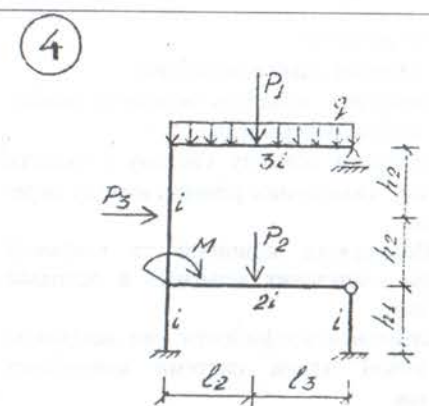

No	l_1	l_2	h_1	h_2	P_1	P_2	P_3	q	M
1	2	3	4	2	12	6	0	6	0
2	3	3	4	3	0	10	8	8	24
3	4	3	5	3	14	6	0	4	0
4	2	4	4	2	20	0	8	6	0
5	3	3	5	4	0	12	6	1	16
6	4	3	5	4	12	0	8	8	0

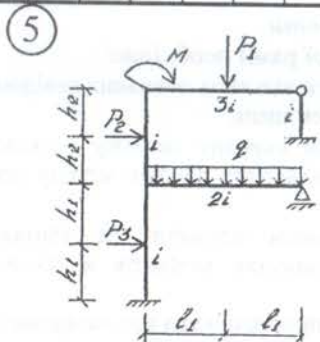

No	l_1	l_2	h_1	h_2	P_1	P_2	P_3	q	M
1	2	3	4	2	12	6	0	6	0
2	3	3	4	3	0	10	8	8	24
3	4	3	5	3	14	6	0	4	0
4	2	4	4	2	20	0	8	6	0
5	3	3	5	4	0	12	6	1	16
6	4	3	5	4	12	0	8	8	0

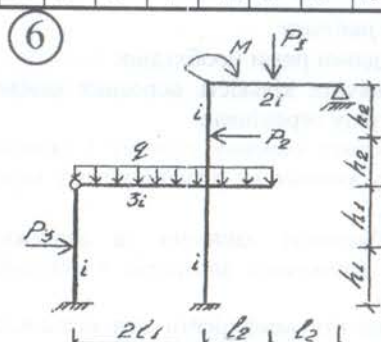

No	l_1	l_2	h_1	h_2	P_1	P_2	P_3	q	M
1	2	2	4	2	12	6	0	6	0
2	3	1	4	3	0	10	8	8	24
3	4	1	5	3	14	6	0	4	0
4	2	2	4	2	20	0	8	6	0
5	3	2	5	4	0	12	6	1	16
6	4	2	5	4	12	0	8	8	0

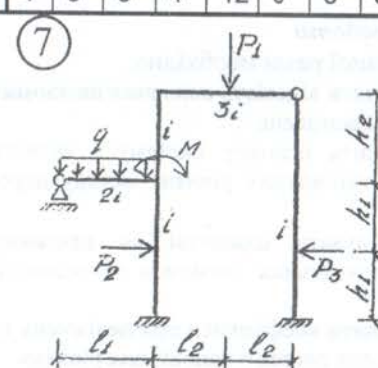

No	l_1	l_2	h_1	h_2	P_1	P_2	P_3	q	M
1	2	3	4	2	12	6	0	6	0
2	3	3	4	3	0	10	8	8	24
3	4	3	5	3	14	6	0	4	0
4	2	4	4	2	20	0	8	6	0
5	3	3	5	4	0	12	6	1	16
6	4	3	5	4	12	0	8	8	0

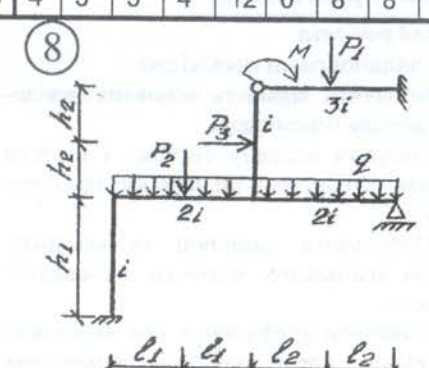

No	l_1	l_2	h_1	h_2	P_1	P_2	P_3	q	M
1	2	3	4	2	12	6	0	6	0
2	3	3	4	3	0	10	8	8	24
3	4	3	5	3	14	6	0	4	0
4	2	4	4	2	20	0	8	6	0
5	3	3	5	4	0	12	6	1	16
6	4	3	5	4	12	0	8	8	0

9

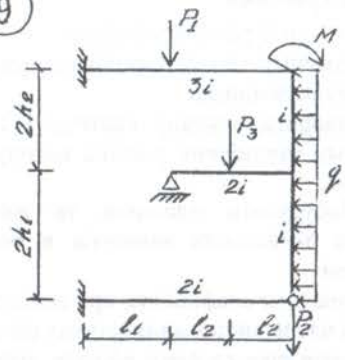

No	l_1	l_2	h_1	h_2	P_1	P_2	P_3	q	M
1	2	3	4	2	12	6	0	6	0
2	3	3	4	3	0	10	8	8	24
3	4	3	5	3	14	6	0	4	0
4	2	4	4	2	20	0	8	6	0
5	3	3	5	4	0	12	6	1	16
6	4	3	5	4	12	0	8	8	0

10

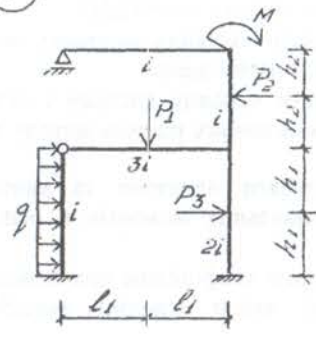

No	l_1	l_2	h_1	h_2	P_1	P_2	P_3	q	M
1	2	3	4	2	12	6	0	6	0
2	3	3	4	3	0	10	8	8	24
3	4	3	5	3	14	6	0	4	0
4	2	4	4	2	20	0	8	6	0
5	3	3	5	4	0	12	6	1	16
6	4	3	5	4	12	0	8	8	0

11

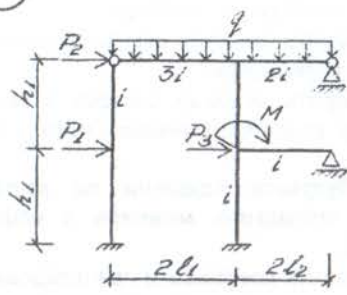

No	l_1	l_2	h_1	h_2	P_1	P_2	P_3	q	M
1	2	3	4	2	12	6	0	6	0
2	3	3	4	3	0	10	8	8	24
3	4	3	5	3	14	6	0	4	0
4	2	4	4	2	20	0	8	6	0
5	3	3	5	4	0	12	6	1	16
6	4	3	5	4	12	0	8	8	0

12

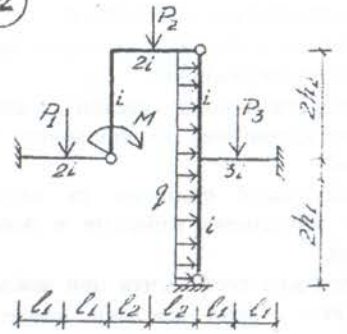

No	l_1	l_2	h_1	h_2	P_1	P_2	P_3	q	M
1	2	3	4	2	12	6	0	6	0
2	3	3	4	3	0	10	8	8	24
3	4	3	5	3	14	6	0	4	0
4	2	4	4	2	20	0	8	6	0
5	3	3	5	4	0	12	6	1	16
6	4	3	5	4	12	0	8	8	0

13

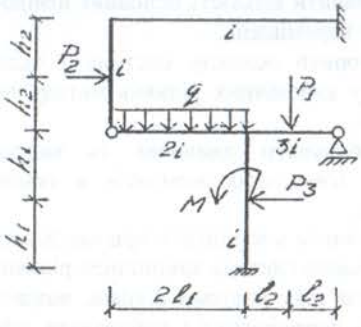

No	l_1	l_2	h_1	h_2	P_1	P_2	P_3	q	M
1	2	3	4	2	12	6	0	6	0
2	3	3	4	3	0	10	8	8	24
3	4	3	5	3	14	6	0	4	0
4	2	4	4	2	20	0	8	6	0
5	3	3	5	4	0	12	6	1	16
6	4	3	5	4	12	0	8	8	0

14

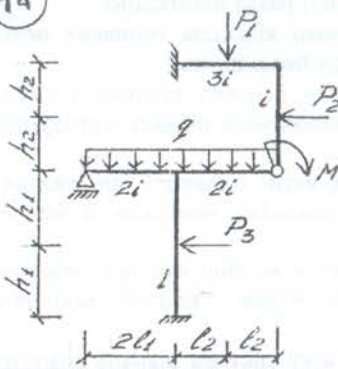

No	l_1	l_2	h_1	h_2	P_1	P_2	P_3	q	M
1	2	3	4	2	12	6	0	6	0
2	3	3	4	3	0	10	8	8	24
3	4	3	5	3	14	6	0	4	0
4	2	4	4	2	20	0	8	6	0
5	3	3	5	4	0	12	6	1	16
6	4	3	5	4	12	0	8	8	0

15

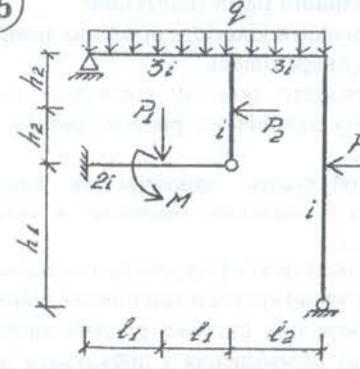

No	l_1	l_2	h_1	h_2	P_1	P_2	P_3	q	M
1	2	3	4	2	12	6	0	6	0
2	3	3	4	3	0	10	8	8	24
3	4	3	5	3	14	6	0	4	0
4	2	4	4	2	20	0	8	6	0
5	3	3	5	4	0	12	6	1	16
6	4	3	5	4	12	0	8	8	0

16

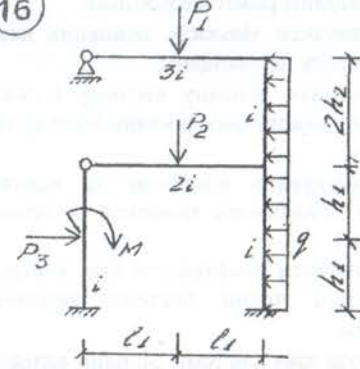

No	l_1	l_2	h_1	h_2	P_1	P_2	P_3	q	M
1	2	3	4	2	12	6	0	6	0
2	3	3	4	3	0	10	8	8	24
3	4	3	5	3	14	6	0	4	0
4	2	4	4	2	20	0	8	6	0
5	3	3	5	4	0	12	6	1	16
6	4	3	5	4	12	0	8	8	0

17

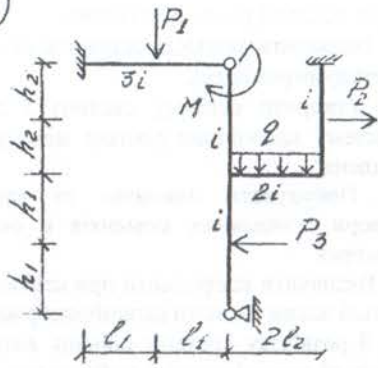

No	l_1	l_2	h_1	h_2	P_1	P_2	P_3	q	M
1	2	3	4	2	12	6	0	6	0
2	3	3	4	3	0	10	8	8	24
3	4	3	5	3	14	6	0	4	0
4	2	4	4	2	20	0	8	6	0
5	3	3	5	4	0	12	6	1	16
6	4	3	5	4	12	0	8	8	0

18

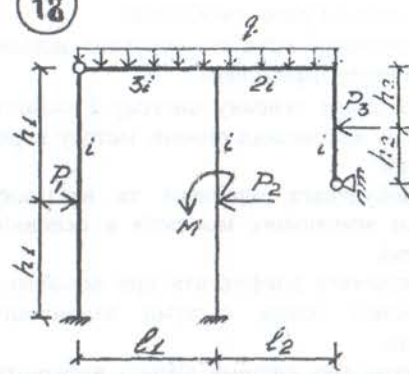

No	l_1	l_2	h_1	h_2	P_1	P_2	P_3	q	M
1	2	3	4	2	12	6	0	6	0
2	3	3	4	3	0	10	8	8	24
3	4	3	5	3	14	6	0	4	0
4	2	4	4	2	20	0	8	6	0
5	3	3	5	4	0	12	6	1	16
6	4	3	5	4	12	0	8	8	0

19

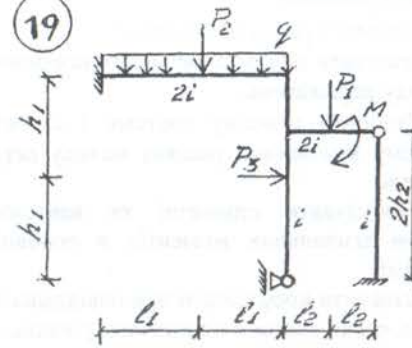

No	l_1	l_2	h_1	h_2	P_1	P_2	P_3	q	M
1	2	3	4	2	12	6	0	6	0
2	3	3	4	3	0	10	8	8	24
3	4	3	5	3	14	6	0	4	0
4	2	4	4	2	20	0	8	6	0
5	3	3	5	4	0	12	6	1	16
6	4	3	5	4	12	0	8	8	0

20

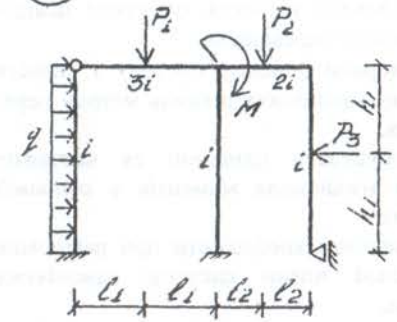

No	l_1	l_2	h_1	h_2	P_1	P_2	P_3	q	M
1	2	3	4	2	12	6	0	6	0
2	3	3	4	3	0	10	8	8	24
3	4	3	5	3	14	6	0	4	0
4	2	4	4	2	20	0	8	6	0
5	3	3	5	4	0	12	6	1	16
6	4	3	5	4	12	0	8	8	0

21

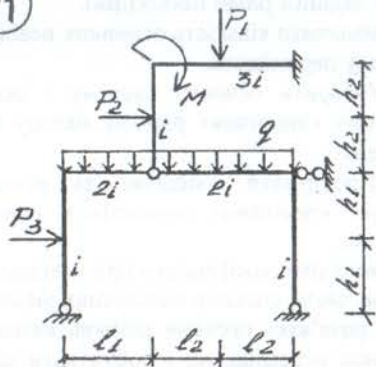

No	l_1	l_2	h_1	h_2	P_1	P_2	P_3	q	M
1	2	3	4	2	12	6	0	6	0
2	3	3	4	3	0	10	8	8	24
3	4	3	5	3	14	6	0	4	0
4	2	4	4	2	20	0	8	6	0
5	3	3	5	4	0	12	6	1	16
6	4	3	5	4	12	0	8	8	0

22

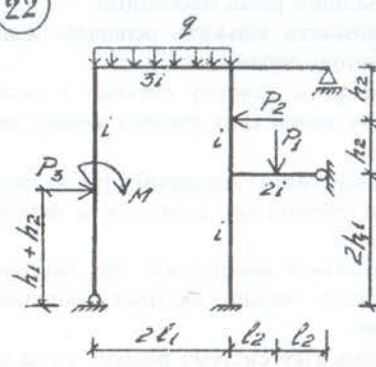

No	l_1	l_2	h_1	h_2	P_1	P_2	P_3	q	M
1	2	3	4	2	12	6	0	6	0
2	3	3	4	3	0	10	8	8	24
3	4	3	5	3	14	6	0	4	0
4	2	4	4	2	20	0	8	6	0
5	3	3	5	4	0	12	6	1	16
6	4	3	5	4	12	0	8	8	0

23

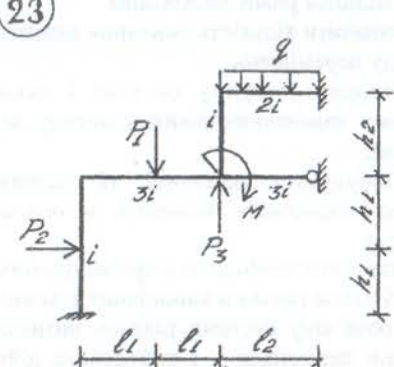

No	l_1	l_2	h_1	h_2	P_1	P_2	P_3	q	M
1	2	3	4	2	12	6	0	6	0
2	3	3	4	3	0	10	8	8	24
3	4	3	5	3	14	6	0	4	0
4	2	4	4	2	20	0	8	6	0
5	3	3	5	4	0	12	6	1	16
6	4	3	5	4	12	0	8	8	0

24

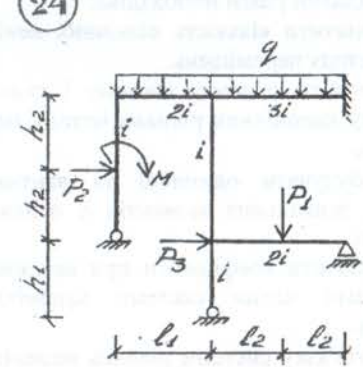

No	l_1	l_2	h_1	h_2	P_1	P_2	P_3	q	M
1	2	3	4	2	12	6	0	6	0
2	3	3	4	3	0	10	8	8	24
3	4	3	5	3	14	6	0	4	0
4	2	4	4	2	20	0	8	6	0
5	3	3	5	4	0	12	6	1	16
6	4	3	5	4	12	0	8	8	0

25

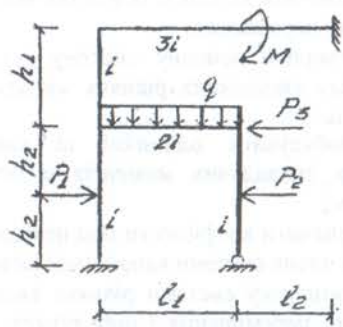

No	l_1	l_2	h_1	h_2	P_1	P_2	P_3	q	M
1	2	3	4	2	12	6	0	6	0
2	3	3	4	3	0	10	8	8	24
3	4	3	5	3	14	6	0	4	0
4	2	4	4	2	20	0	8	6	0
5	3	3	5	4	0	12	6	1	16
6	4	3	5	4	12	0	8	8	0

26

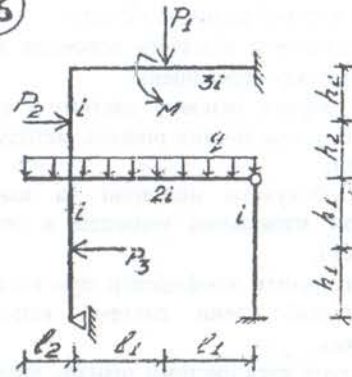

No	l_1	l_2	h_1	h_2	P_1	P_2	P_3	q	M
1	2	1	4	2	12	6	0	6	0
2	3	1	4	3	0	10	8	8	24
3	4	1	5	3	14	6	0	4	0
4	2	2	4	2	20	0	8	6	0
5	3	2	5	4	0	12	6	1	16
6	4	2	5	4	12	0	8	8	0

27

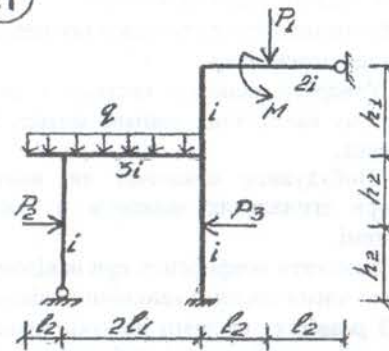

No	l_1	l_2	h_1	h_2	P_1	P_2	P_3	q	M
1	2	2	4	2	12	6	0	6	0
2	3	2	4	3	0	10	8	8	24
3	4	2	5	3	14	6	0	4	0
4	2	2	4	2	20	0	8	6	0
5	3	2	5	4	0	12	6	1	16
6	4	2	5	4	12	0	8	8	0

28

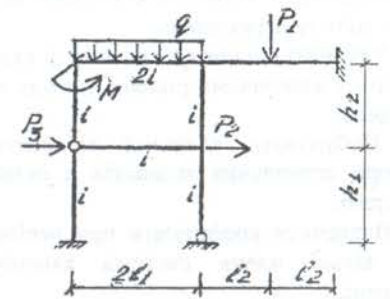

No	l_1	l_2	h_1	h_2	P_1	P_2	P_3	q	M
1	2	3	4	2	12	6	0	6	0
2	3	3	4	3	0	10	8	8	24
3	4	3	5	3	14	6	0	4	0
4	2	4	4	2	20	0	8	6	0
5	3	3	5	4	0	12	6	1	16
6	4	3	5	4	12	0	8	8	0

29

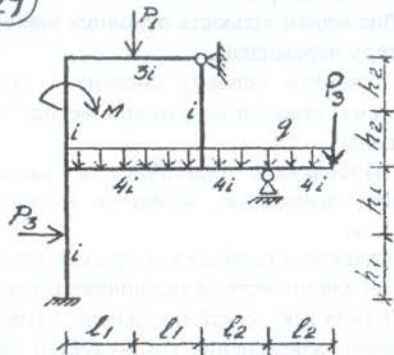

No	l_1	l_2	h_1	h_2	P_1	P_2	P_3	q	M
1	2	1	4	2	12	6	0	6	0
2	3	1	4	3	0	10	8	8	24
3	4	2	5	3	14	6	0	4	0
4	2	2	4	2	20	0	8	6	0
5	3	2	5	4	0	12	6	1	16
6	4	2	5	4	12	0	8	8	0

30

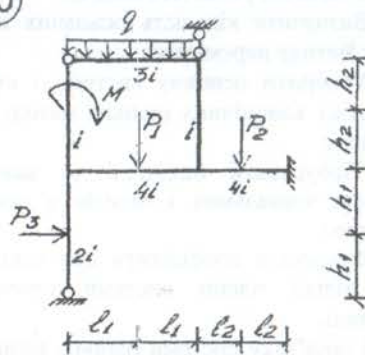

No	l_1	l_2	h_1	h_2	P_1	P_2	P_3	q	M
1	2	3	4	2	12	6	0	6	0
2	3	3	4	3	0	10	8	8	24
3	4	3	5	3	14	6	0	4	0
4	2	4	4	2	20	0	8	6	0
5	3	3	5	4	0	12	6	1	16
6	4	3	5	4	12	0	8	8	0

31

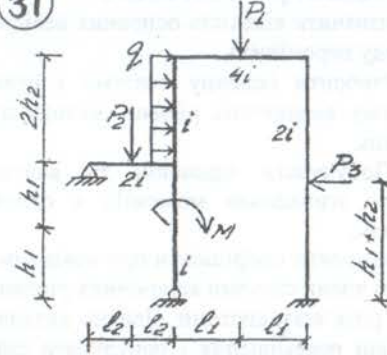

No	l_1	l_2	h_1	h_2	P_1	P_2	P_3	q	M
1	2	3	4	2	12	6	0	6	0
2	3	3	4	3	0	10	8	8	24
3	4	3	5	3	14	6	0	4	0
4	2	4	4	2	20	0	8	6	0
5	3	3	5	4	0	12	6	1	16
6	4	3	5	4	12	0	8	8	0

32

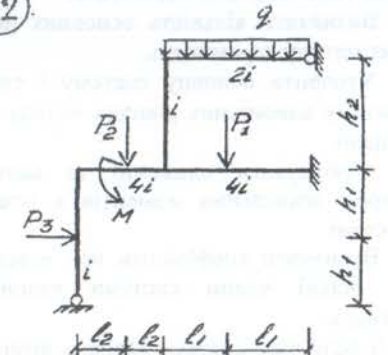

No	l_1	l_2	h_1	h_2	P_1	P_2	P_3	q	M
1	2	3	4	2	12	6	0	6	0
2	3	3	4	3	0	10	8	8	24
3	4	3	5	3	14	6	0	4	0
4	2	4	4	2	20	0	8	6	0
5	3	3	5	4	0	12	6	1	16
6	4	3	5	4	12	0	8	8	0

33

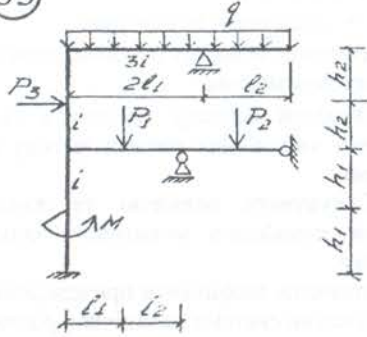

No	l_1	l_2	h_1	h_2	P_1	P_2	P_3	q	M
1	2	1	4	2	12	6	0	6	0
2	3	1	4	3	0	10	8	8	24
3	4	1	5	3	14	6	0	4	0
4	2	2	4	2	20	0	8	6	0
5	3	2	5	4	0	12	6	1	16
6	4	2	5	4	12	0	8	8	0

34

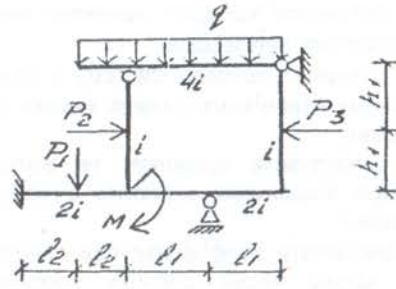

No	l_1	l_2	h_1	h_2	P_1	P_2	P_3	q	M
1	2	2	4	2	12	6	0	6	0
2	3	2	4	3	0	10	8	8	24
3	4	2	5	3	14	6	0	4	0
4	2	2	4	2	20	0	8	6	0
5	3	2	5	4	0	12	6	1	16
6	4	1	5	4	12	0	8	8	0

35

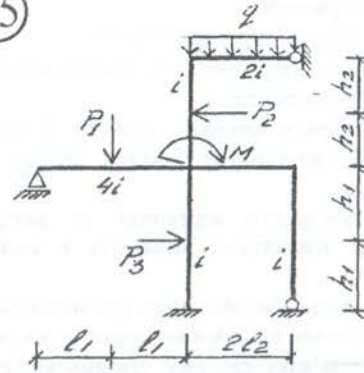

No	l_1	l_2	h_1	h_2	P_1	P_2	P_3	q	M
1	2	3	4	2	12	6	0	6	0
2	3	3	4	3	0	10	8	8	24
3	4	3	5	3	14	6	0	4	0
4	2	4	4	2	20	0	8	6	0
5	3	3	5	4	0	12	6	1	16
6	4	3	5	4	12	0	8	8	0

36

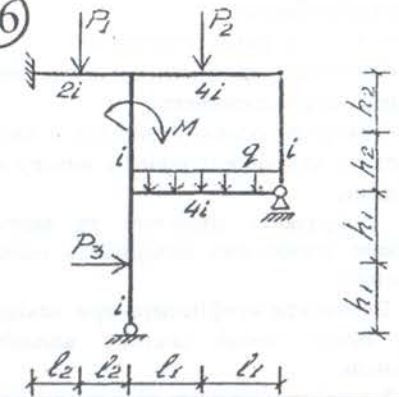

No	l_1	l_2	h_1	h_2	P_1	P_2	P_3	q	M
1	2	3	4	2	12	6	0	6	0
2	3	3	4	3	0	10	8	8	24
3	4	3	5	3	14	6	0	4	0
4	2	4	4	2	20	0	8	6	0
5	3	3	5	4	0	12	6	1	16
6	4	3	5	4	12	0	8	8	0

37

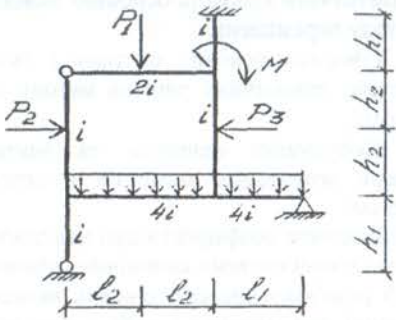

No	l_1	l_2	h_1	h_2	P_1	P_2	P_3	q	M
1	2	3	4	2	12	6	0	6	0
2	3	3	4	3	0	10	8	8	24
3	4	3	5	3	14	6	0	4	0
4	2	4	4	2	20	0	8	6	0
5	3	3	5	4	0	12	6	1	16
6	4	3	5	4	12	0	8	8	0

38

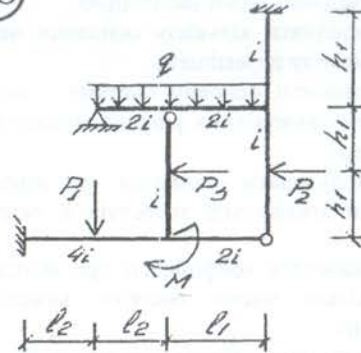

No	l_1	l_2	h_1	h_2	P_1	P_2	P_3	q	M
1	2	3	4	2	12	6	0	6	0
2	3	3	4	3	0	10	8	8	24
3	4	3	5	3	14	6	0	4	0
4	2	4	4	2	20	0	8	6	0
5	3	3	5	4	0	12	6	1	16
6	4	3	5	4	12	0	8	8	0

39

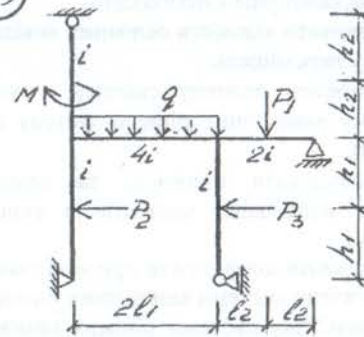

No	l_1	l_2	h_1	h_2	P_1	P_2	P_3	q	M
1	2	3	4	2	12	6	0	6	0
2	3	3	4	3	0	10	8	8	24
3	4	3	5	3	14	6	0	4	0
4	2	4	4	2	20	0	8	6	0
5	3	3	5	4	0	12	6	1	16
6	4	3	5	4	12	0	8	8	0

40

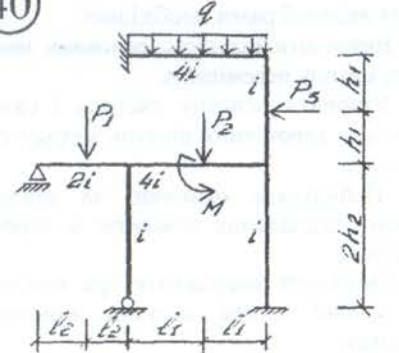

No	l_1	l_2	h_1	h_2	P_1	P_2	P_3	q	M
1	2	3	4	2	12	6	0	6	0
2	3	3	4	3	0	10	8	8	24
3	4	3	5	3	14	6	0	4	0
4	2	4	4	2	20	0	8	6	0
5	3	3	5	4	0	12	6	1	16
6	4	3	5	4	12	0	8	8	0

41

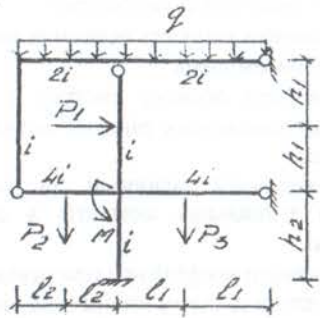

No	l_1	l_2	h_1	h_2	P_1	P_2	P_3	q	M
1	2	3	4	2	12	6	0	6	0
2	3	3	4	3	0	10	8	8	24
3	4	3	5	3	14	6	0	4	0
4	2	4	4	2	20	0	8	6	0
5	3	3	5	4	0	12	6	1	16
6	4	3	5	4	12	0	8	8	0

42

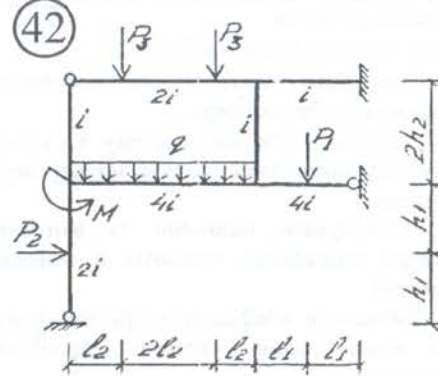

No	l_1	l_2	h_1	h_2	P_1	P_2	P_3	q	M
1	2	3	4	2	12	6	0	6	0
2	3	3	4	3	0	10	8	8	24
3	4	3	5	3	14	6	0	4	0
4	2	4	4	2	20	0	8	6	0
5	3	3	5	4	0	12	6	1	16
6	4	3	5	4	12	0	8	8	0

43

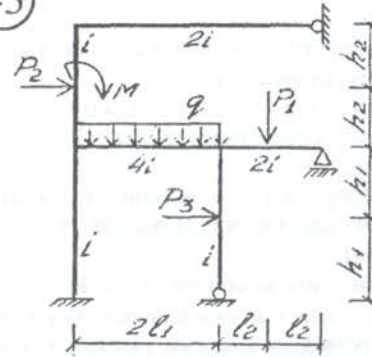

No	l_1	l_2	h_1	h_2	P_1	P_2	P_3	q	M
1	2	3	4	2	12	6	0	6	0
2	3	3	4	3	0	10	8	8	24
3	4	3	5	3	14	6	0	4	0
4	2	4	4	2	20	0	8	6	0
5	3	3	5	4	0	12	6	1	16
6	4	3	5	4	12	0	8	8	0

44

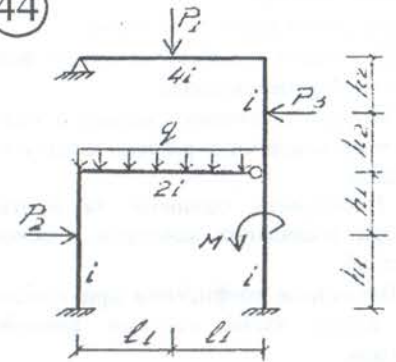

No	l_1	l_2	h_1	h_2	P_1	P_2	P_3	q	M
1	2	3	4	2	12	6	0	6	0
2	3	3	4	3	0	10	8	8	24
3	4	3	5	3	14	6	0	4	0
4	2	4	4	2	20	0	8	6	0
5	3	3	5	4	0	12	6	1	16
6	4	3	5	4	12	0	8	8	0

45

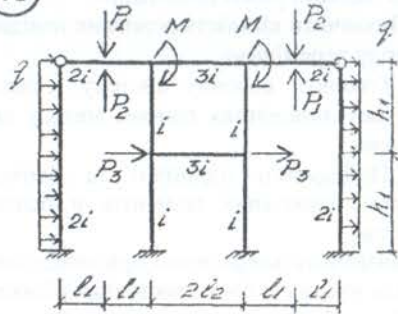

No	l_1	l_2	h_1	h_2	P_1	P_2	P_3	q	M
1	2	3	4	2	12	6	0	6	0
2	3	3	4	3	0	10	8	8	24
3	4	3	5	3	14	6	0	4	0
4	2	4	4	2	20	0	8	6	0
5	3	3	5	4	0	12	6	1	16
6	4	3	5	4	12	0	8	8	0

46

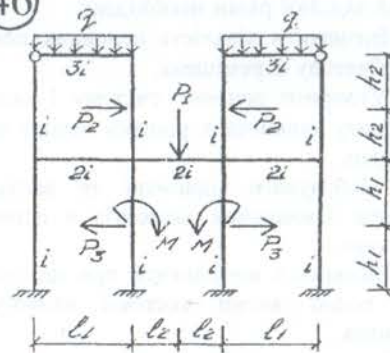

No	l_1	l_2	h_1	h_2	P_1	P_2	P_3	q	M
1	2	3	4	2	12	6	0	6	0
2	3	3	4	3	0	10	8	8	24
3	4	3	5	3	14	6	0	4	0
4	2	4	4	2	20	0	8	6	0
5	3	3	5	4	0	12	6	1	16
6	4	3	5	4	12	0	8	8	0

47

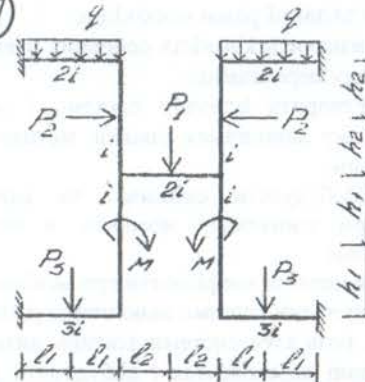

No	l_1	l_2	h_1	h_2	P_1	P_2	P_3	q	M
1	2	3	4	2	12	6	0	6	0
2	3	3	4	3	0	10	8	8	24
3	4	3	5	3	14	6	0	4	0
4	2	4	4	2	20	0	8	6	0
5	3	3	5	4	0	12	6	1	16
6	4	3	5	4	12	0	8	8	0

48

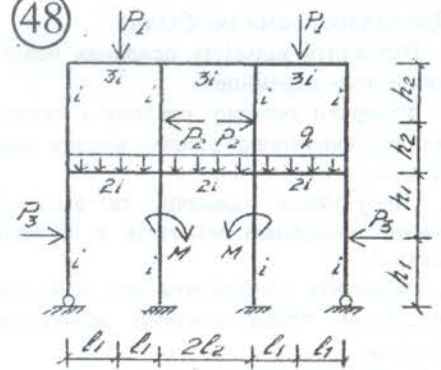

No	l_1	l_2	h_1	h_2	P_1	P_2	P_3	q	M
1	2	3	4	2	12	6	0	6	0
2	3	3	4	3	0	10	8	8	24
3	4	3	5	3	14	6	0	4	0
4	2	4	4	2	20	0	8	6	0
5	3	3	5	4	0	12	6	1	16
6	4	3	5	4	12	0	8	8	0

65

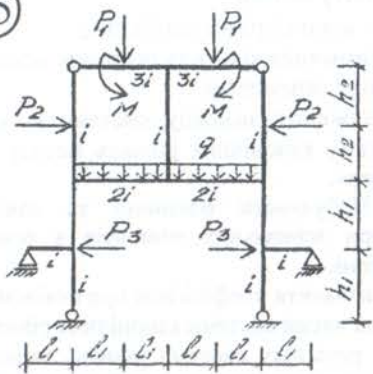

No	l_1	l_2	h_1	h_2	P_1	P_2	P_3	q	M
1	2	3	4	2	12	6	0	6	0
2	3	3	4	3	0	10	8	8	24
3	4	3	5	3	14	6	0	4	0
4	2	4	4	2	20	0	8	6	0
5	3	3	5	4	0	12	6	1	16
6	4	3	5	4	12	0	8	8	0

66

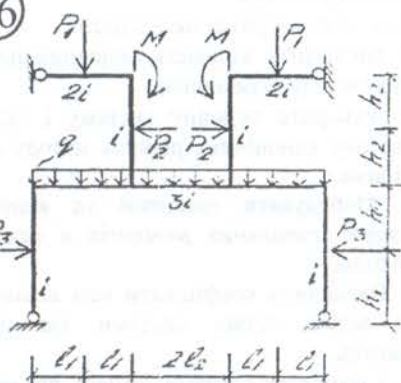

No	l_1	l_2	h_1	h_2	P_1	P_2	P_3	q	M
1	2	3	4	2	12	6	0	6	0
2	3	3	4	3	0	10	8	8	24
3	4	3	5	3	14	6	0	4	0
4	2	4	4	2	20	0	8	6	0
5	3	3	5	4	0	12	6	1	16
6	4	3	5	4	12	0	8	8	0

67

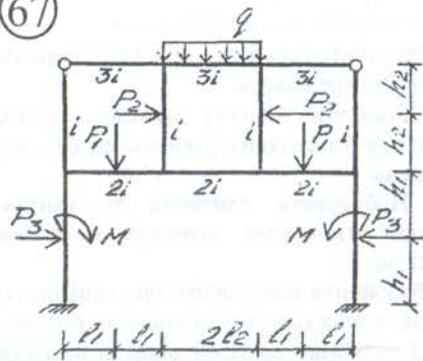

No	l_1	l_2	h_1	h_2	P_1	P_2	P_3	q	M
1	2	3	4	2	12	6	0	6	0
2	3	3	4	3	0	10	8	8	24
3	4	3	5	3	14	6	0	4	0
4	2	4	4	2	20	0	8	6	0
5	3	3	5	4	0	12	6	1	16
6	4	3	5	4	12	0	8	8	0

68

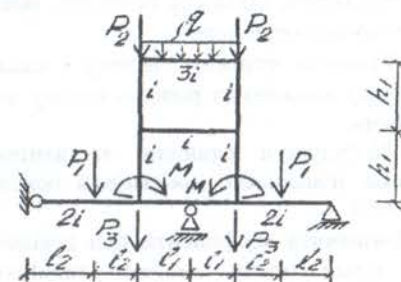

No	l_1	l_2	h_1	h_2	P_1	P_2	P_3	q	M
1	2	3	4	2	12	6	0	6	0
2	3	3	4	3	0	10	8	8	24
3	4	3	5	3	14	6	0	4	0
4	2	4	4	2	20	0	8	6	0
5	3	3	5	4	0	12	6	1	16
6	4	3	5	4	12	0	8	8	0

69

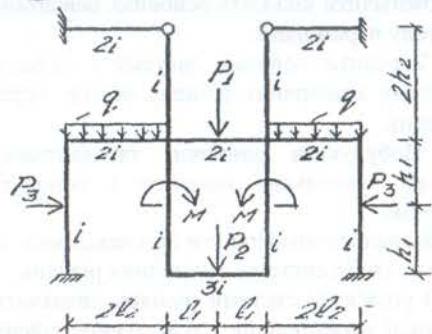

No	l_1	l_2	h_1	h_2	P_1	P_2	P_3	q	M
1	2	3	4	2	12	6	0	6	0
2	3	3	4	3	0	10	8	8	24
3	4	3	5	3	14	6	0	4	0
4	2	4	4	2	20	0	8	6	0
5	3	3	5	4	0	12	6	1	16
6	4	3	5	4	12	0	8	8	0

70

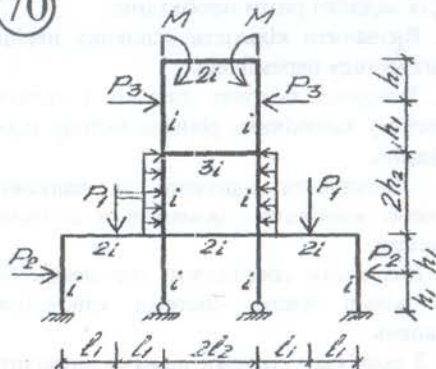

No	l_1	l_2	h_1	h_2	P_1	P_2	P_3	q	M
1	2	3	4	2	12	6	0	6	0
2	3	3	4	3	0	10	8	8	24
3	4	3	5	3	14	6	0	4	0
4	2	4	4	2	20	0	8	6	0
5	3	3	5	4	0	12	6	1	16
6	4	3	5	4	12	0	8	8	0

71

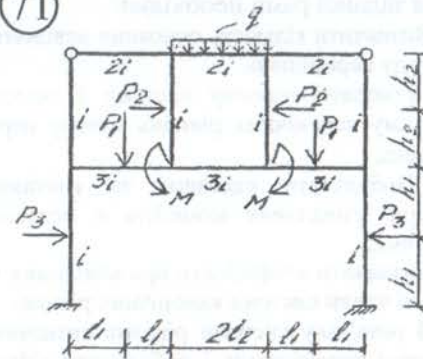

No	l_1	l_2	h_1	h_2	P_1	P_2	P_3	q	M
1	2	3	4	2	12	6	0	6	0
2	3	3	4	3	0	10	8	8	24
3	4	3	5	3	14	6	0	4	0
4	2	4	4	2	20	0	8	6	0
5	3	3	5	4	0	12	6	1	16
6	4	3	5	4	12	0	8	8	0

72

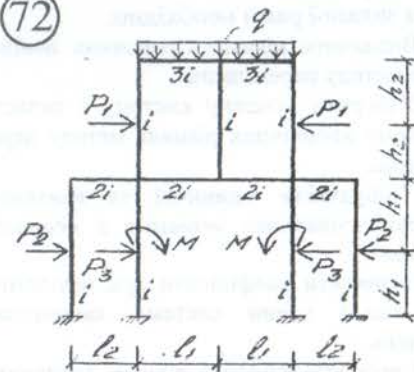

No	l_1	l_2	h_1	h_2	P_1	P_2	P_3	q	M
1	2	3	4	2	12	6	0	6	0
2	3	3	4	3	0	10	8	8	24
3	4	3	5	3	14	6	0	4	0
4	2	4	4	2	20	0	8	6	0
5	3	3	5	4	0	12	6	1	16
6	4	3	5	4	12	0	8	8	0

73

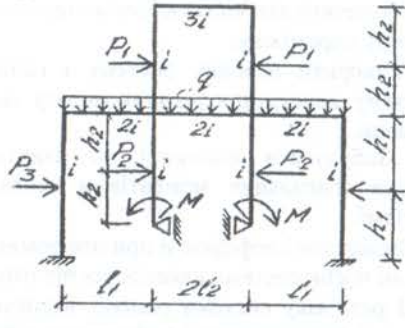

No	l_1	l_2	h_1	h_2	P_1	P_2	P_3	q	M
1	2	3	4	2	12	6	0	6	0
2	3	3	4	3	0	10	8	8	24
3	4	3	5	3	14	6	0	4	0
4	2	4	4	2	20	0	8	6	0
5	3	3	5	4	0	12	6	1	16
6	4	3	5	4	12	0	8	8	0

74

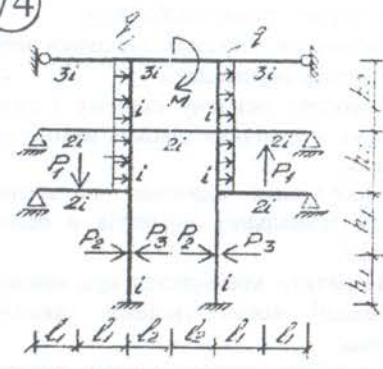

No	l_1	l_2	h_1	h_2	P_1	P_2	P_3	q	M
1	2	3	4	2	12	6	0	6	0
2	3	3	4	3	0	10	8	8	24
3	4	3	5	3	14	6	0	4	0
4	2	4	4	2	20	0	8	6	0
5	3	3	5	4	0	12	6	1	16
6	4	3	5	4	12	0	8	8	0

75

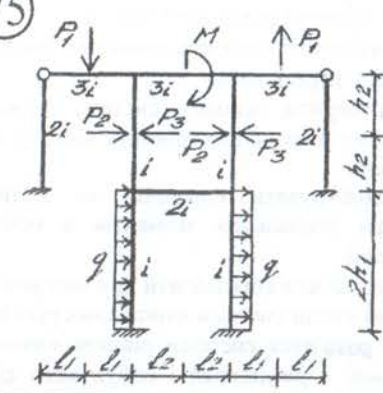

No	l_1	l_2	h_1	h_2	P_1	P_2	P_3	q	M
1	2	3	4	2	12	6	0	6	0
2	3	3	4	3	0	10	8	8	24
3	4	3	5	3	14	6	0	4	0
4	2	4	4	2	20	0	8	6	0
5	3	3	5	4	0	12	6	1	16
6	4	3	5	4	12	0	8	8	0

76

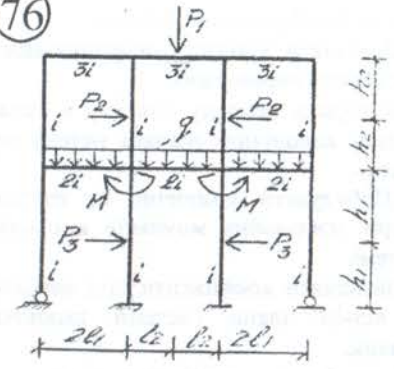

No	l_1	l_2	h_1	h_2	P_1	P_2	P_3	q	M
1	2	3	4	2	12	6	0	6	0
2	3	3	4	3	0	10	8	8	24
3	4	3	5	3	14	6	0	4	0
4	2	4	4	2	20	0	8	6	0
5	3	3	5	4	0	12	6	1	16
6	4	3	5	4	12	0	8	8	0

77

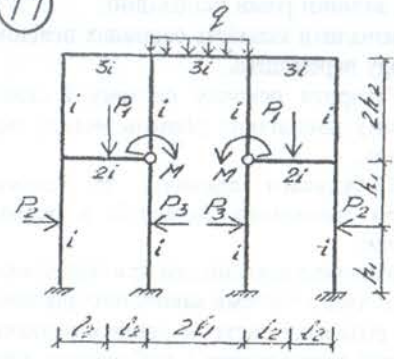

No	l_1	l_2	h_1	h_2	P_1	P_2	P_3	q	M
1	2	3	4	2	12	6	0	6	0
2	3	3	4	3	0	10	8	8	24
3	4	3	5	3	14	6	0	4	0
4	2	4	4	2	20	0	8	6	0
5	3	3	5	4	0	12	6	1	16
6	4	3	5	4	12	0	8	8	0

78

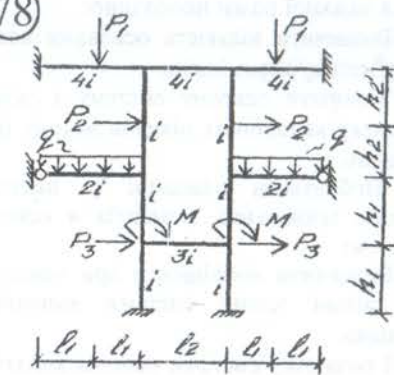

No	l_1	l_2	h_1	h_2	P_1	P_2	P_3	q	M
1	2	3	4	2	12	6	0	6	0
2	3	3	4	3	0	10	8	8	24
3	4	3	5	3	14	6	0	4	0
4	2	4	4	2	20	0	8	6	0
5	3	3	5	4	0	12	6	1	16
6	4	3	5	4	12	0	8	8	0

79

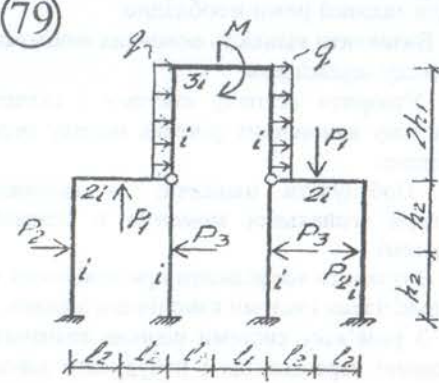

No	l_1	l_2	h_1	h_2	P_1	P_2	P_3	q	M
1	2	3	4	2	12	6	0	6	0
2	3	3	4	3	0	10	8	8	24
3	4	3	5	3	14	6	0	4	0
4	2	4	4	2	20	0	8	6	0
5	3	3	5	4	0	12	6	1	16
6	4	3	5	4	12	0	8	8	0

80

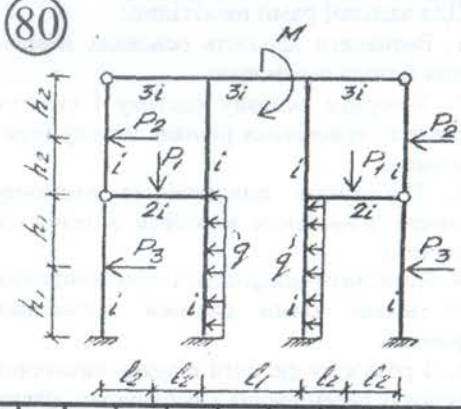

No	l_1	l_2	h_1	h_2	P_1	P_2	P_3	q	M
1	2	3	4	2	12	6	0	6	0
2	3	3	4	3	0	10	8	8	24
3	4	3	5	3	14	6	0	4	0
4	2	4	4	2	20	0	8	6	0
5	3	3	5	4	0	12	6	1	16
6	4	3	5	4	12	0	8	8	0

81

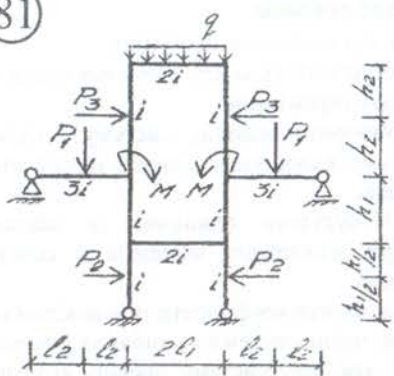

No	l_1	l_2	h_1	h_2	P_1	P_2	P_3	q	M
1	2	3	4	2	12	6	0	6	0
2	3	3	4	3	0	10	8	8	24
3	4	3	5	3	14	6	0	4	0
4	2	4	4	2	20	0	8	6	0
5	3	3	5	4	0	12	6	1	16
6	4	3	5	4	12	0	8	8	0

82

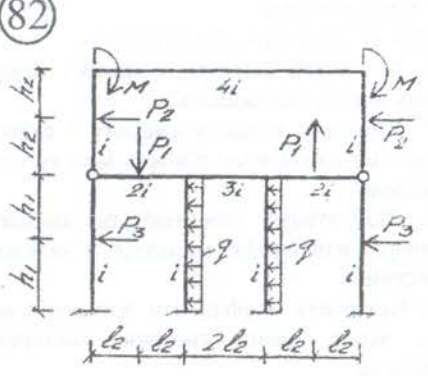

No	l_1	l_2	h_1	h_2	P_1	P_2	P_3	q	M
1	2	3	4	2	12	6	0	6	0
2	3	3	4	3	0	10	8	8	24
3	4	3	5	3	14	6	0	4	0
4	2	4	4	2	20	0	8	6	0
5	3	3	5	4	0	12	6	1	16
6	4	3	5	4	12	0	8	8	0

83

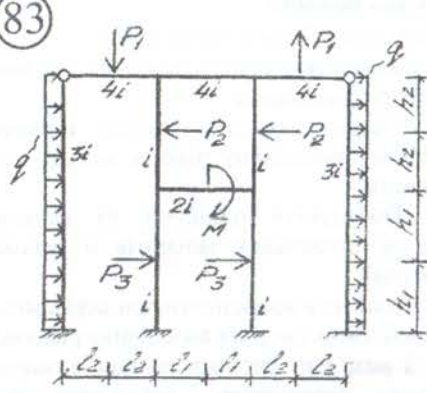

No	l_1	l_2	h_1	h_2	P_1	P_2	P_3	q	M
1	2	3	4	2	12	6	0	6	0
2	3	3	4	3	0	10	8	8	24
3	4	3	5	3	14	6	0	4	0
4	2	4	4	2	20	0	8	6	0
5	3	3	5	4	0	12	6	1	16
6	4	3	5	4	12	0	8	8	0

84

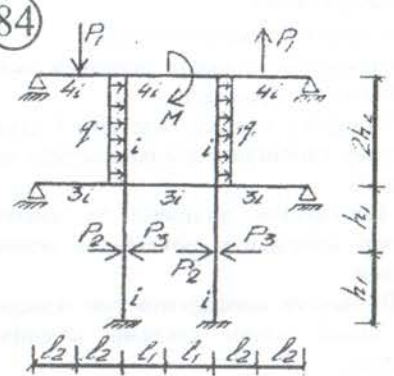

No	l_1	l_2	h_1	h_2	P_1	P_2	P_3	q	M
1	2	3	4	2	12	6	0	6	0
2	3	3	4	3	0	10	8	8	24
3	4	3	5	3	14	6	0	4	0
4	2	4	4	2	20	0	8	6	0
5	3	3	5	4	0	12	6	1	16
6	4	3	5	4	12	0	8	8	0

85

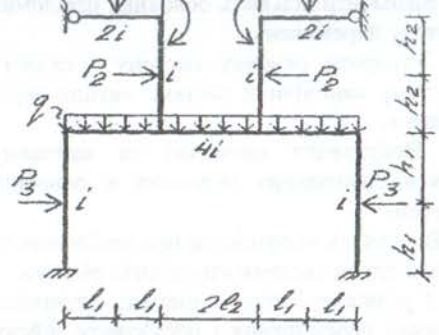

No	l_1	l_2	h_1	h_2	P_1	P_2	P_3	q	M
1	2	3	4	2	12	6	0	6	0
2	3	3	4	3	0	10	8	8	24
3	4	3	5	3	14	6	0	4	0
4	2	4	4	2	20	0	8	6	0
5	3	3	5	4	0	12	6	1	16
6	4	3	5	4	12	0	8	8	0

86

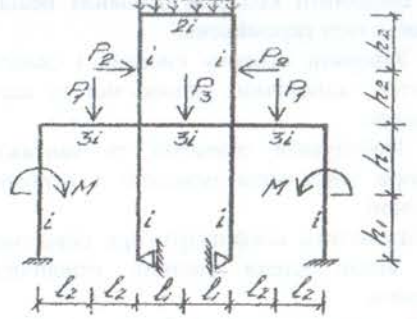

No	l_1	l_2	h_1	h_2	P_1	P_2	P_3	q	M
1	2	3	4	2	12	6	0	6	0
2	3	3	4	3	0	10	8	8	24
3	4	3	5	3	14	6	0	4	0
4	2	4	4	2	20	0	8	6	0
5	3	3	5	4	0	12	6	1	16
6	4	3	5	4	12	0	8	8	0

87

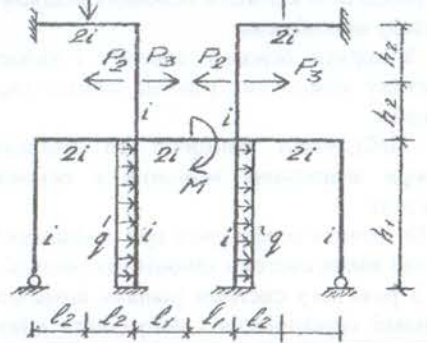

No	l_1	l_2	h_1	h_2	P_1	P_2	P_3	q	M
1	2	3	4	2	12	6	0	6	0
2	3	3	4	3	0	10	8	8	24
3	4	3	5	3	14	6	0	4	0
4	2	4	4	2	20	0	8	6	0
5	3	3	5	4	0	12	6	1	16
6	4	3	5	4	12	0	8	8	0

88

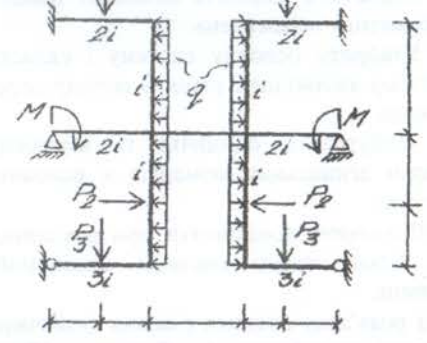

No	l_1	l_2	h_1	h_2	P_1	P_2	P_3	q	M
1	2	3	4	2	12	6	0	6	0
2	3	3	4	3	0	10	8	8	24
3	4	3	5	3	14	6	0	4	0
4	2	4	4	2	20	0	8	6	0
5	3	3	5	4	0	12	6	1	16
6	4	3	5	4	12	0	8	8	0

